

Heber Springs Area Chamber of Commerce

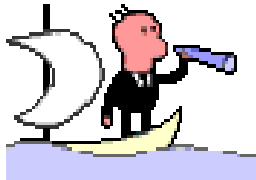

What Floats Your Boat

Cardboard Boat Basics

Construction Rules (Equal Opportunity)

- The ENTIRE BOAT must be built of CARDBOARD
 - Only exceptions are the paddles & decorations
 - Use Cardboard boxes, “blocks”, carpet tubes
 - NO pre-treated cardboard allowed
 - No SONA-TUBES, or waxed or ‘treated’ cardboard
 - NO wood, plastic or fiberglass
 - NO caulking compounds or two-part/mixed adhesives.
 - NO wrapping in duct tape, plastic or fiberglass

Construction Rules

(continued)

- Waterproof the boat with Varnish, Paint or Polyurethane (1-part, paint-like substance)
- Decorations are allowed - as long as they don't effect structural strength or buoyancy
- The crew compartment can NOT be ENCLOSED so as to interfere with escape
- Every crew member must wear a life jacket

Construction Materials

Permissible Materials

- Corrugated Cardboard
 - Appliance or Grocery Stores
- Cardboard “blocks”
 - Furniture stores
- Cardboard Tubes
 - Carpet/Linoleum stores
- Fastening material
 - Duct or masking tape
 - Liquid nails adhesive
 - Latex Paint, Varnish

Materials NOT Allowed

- Wood, Styrofoam
- Plastic sheathing
- Fiberglass
- Sona-Tubes, coated cardboard
- Silicon, Wax, Tar
- Caulking compounds
- Metal
- Staples, clamps, screws
 - * Judges decide on the interpretation of the rules

Construction Materials (continued)

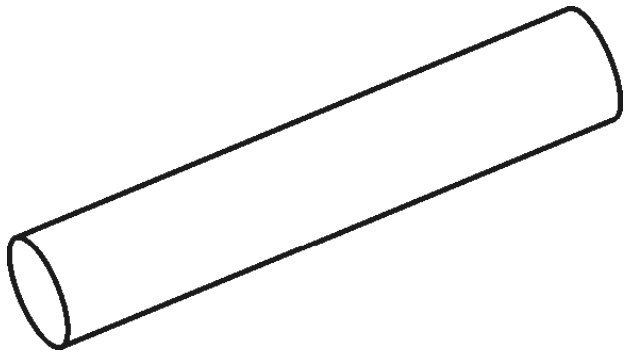

Carpet Tube
(about 4 1/2" dia.)

Cardboard
Block
(2-3" thick)

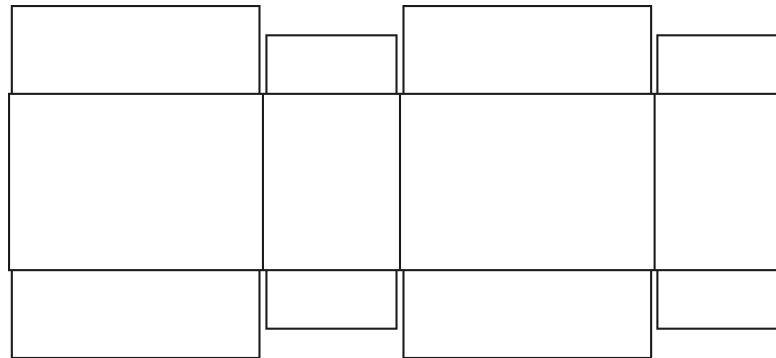
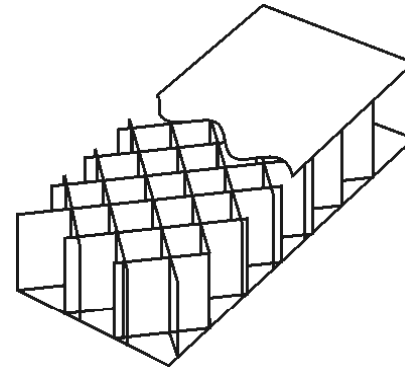

Cardboard Box - cut open

Cardboard Boat Design

- Consider its Size - building & transporting
 - Big enough to hold crew, small enough to carry
 - Wider is better, but still be able to paddle
 - no surfboard style designs are allowed
 - Rafts ARE allowed
 - Consider total weight of all materials when wet
 - EVERYTHING must be removed from the lake
- Boat decorations & crew costumes are encouraged
 - use your imagination

Cardboard Boat 'Physics'

- “How much will you sink? - Displacement

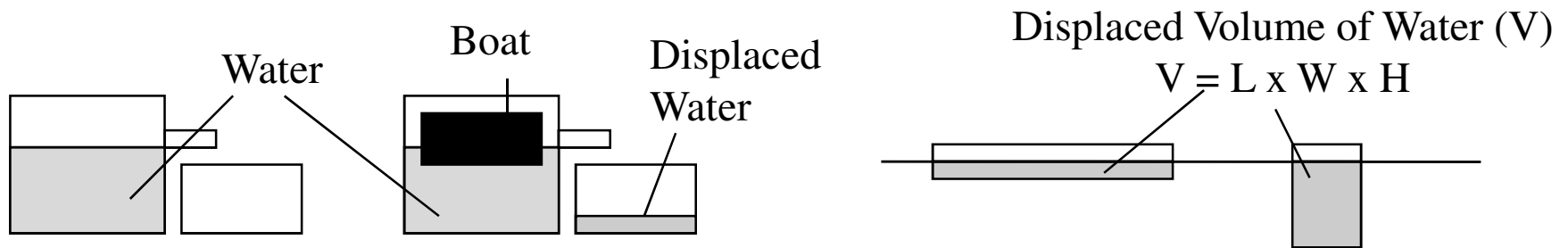

Weight of Water =
62.4 pounds/cubic-foot

$$\text{Water Displaced(ft}^3\text{)} = \frac{\text{Weight-of-boat-}\&\text{-people-lbs}}{62.4 \text{ lbs/ft}^3\text{-H}_2\text{O}}$$

$$\text{Depth(ft) boat sinks} = \frac{\text{Water Displaced(ft}^3\text{)}}{\text{Length X Width of boat (ft}^2\text{)}}$$

Example:

Box boat, 3 ft X 6 ft, 1ft tall (high)

Boat volume = 3' X 6' X 1' = 18 ft³

Boat displacement = 18 ft³ X 62.4 lbs/ft³ = 1123.2 lbs

Which equates to 93.6 lbs per inch of boat height

Cardboard Boat 'Physics'

- “Wider is Better” - Center of Buoyancy

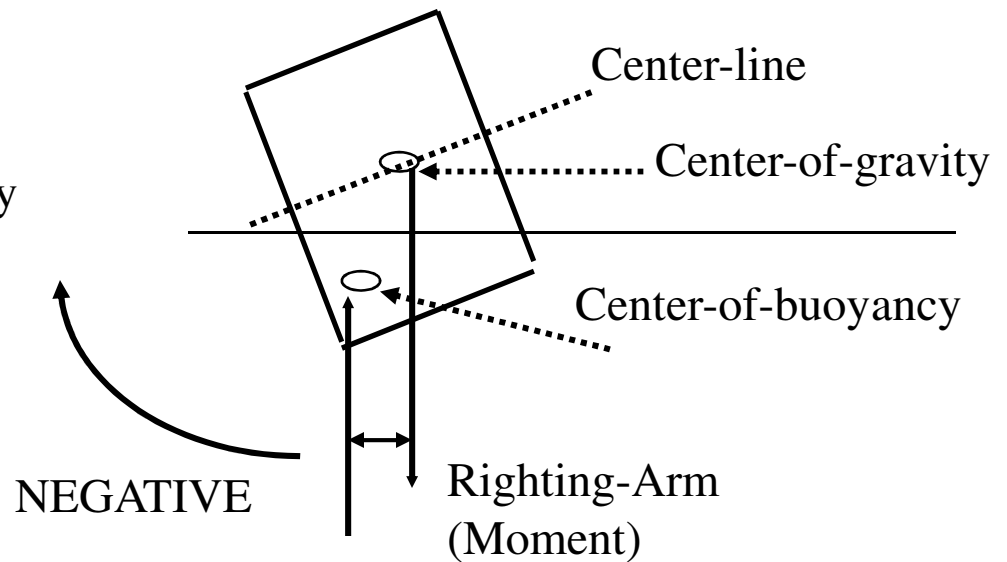
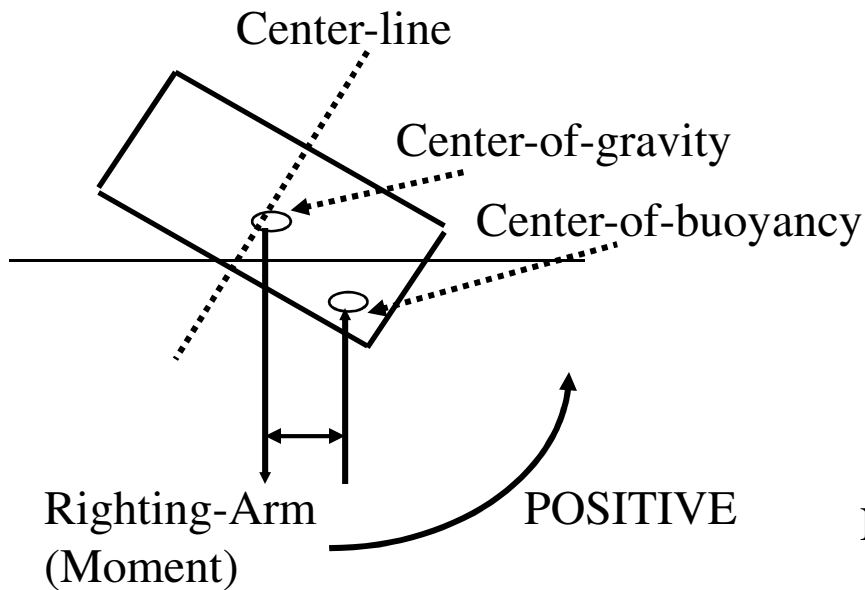

Cardboard Boat 'Physics'

- Movement Through the Water

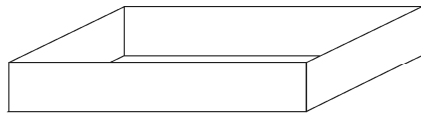

Simple
Box

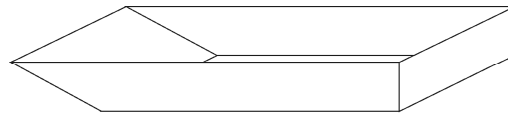

Slanted
Box

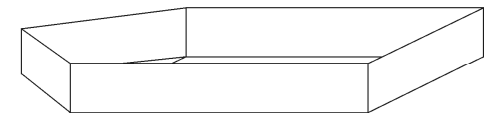

V-Shaped
Bow

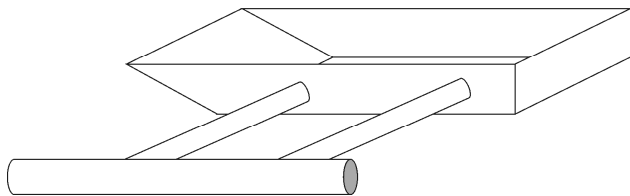

Outrigger
Design

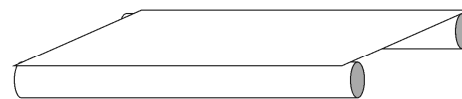

Pontoon
Design

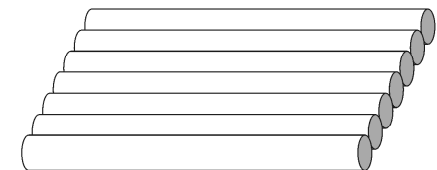

Raft
Design

Cardboard Boat

Design Suggestions

- Set the Design Goal: FUN, Speed or looks
- Sketch out your design
 - build a scale model from manila paper:
 - estimate materials or plan how to use what you have
 - plan out what construction techniques will be used
- 1'x1'x3' box: will float 187 lbs.
 - if it'll hold you, it's big enough to float
- Flat bottoms, sit-to-paddle - are the best/easiest
- Rudders help keep you straight but make turning difficult and adds complexity to your design.

Cardboard Boat

Suggestions (cont'd)

- Long boats go fast - but are harder to turn
- Short boats (<10') - are difficult to keep straight
- Best Length: 8-12 feet
- Best Height: 18 inches
 - allows room to sit/kneel & still paddle over the edge
- Best Width:
 - 18"-30"(max) for 1 person
 - 48" wide for 2 people side by side
- Kneeling is a “power” position but sitting is more comfortable

Construction Tips & Techniques

- Cover edges of cardboard - acts like siphon
- Cardboard Tubes make great frames
 - Cutting for joining & bending
 - Fastening tubes together
- Cardboard Hull
 - 1-2 layers, fasten & cover the seams
 - With 2 layers, overlap the seams
 - Decorate, paint & varnish
- Reinforce the area where you sit, kneel or stand

Construction Tips & Techniques

- Carpenter's glue works well, liquid nails
 - hot-melt glues melts in the sun
- Duct tape only non-painted surfaces (tubes or frame that will be covered)
 - Duct tape shrinks when painted
 - Duct tape can be covered with masking tape if you need to paint it.
 - No Clear tape - it melts when painted
 - Masking tape for glued edges & seams
 - Kraft paper with spray adhesive also

Construction Tips & Techniques

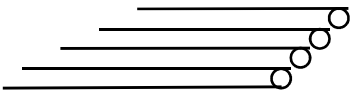

Solid Tube
Frame

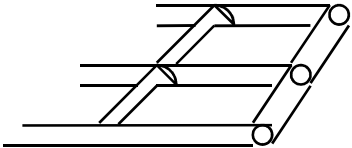

Center/Cross
Beam
Frame

FRAMES

CONNECTING TUBES

Cardboard
Wrapper for Tubes
End-to-End

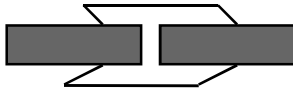

Cardboard
Wrapper for Tubes
At Right-Angles

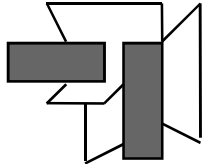

Construction Tips & Techniques

FRAME ANGLES

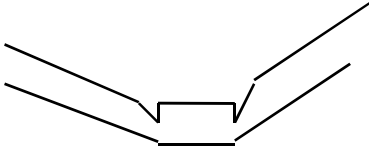

V-Shaped Cuts

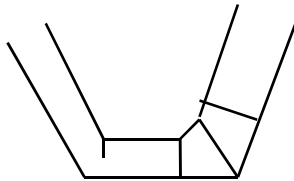

Multiple Cuts
for Sharper Angles

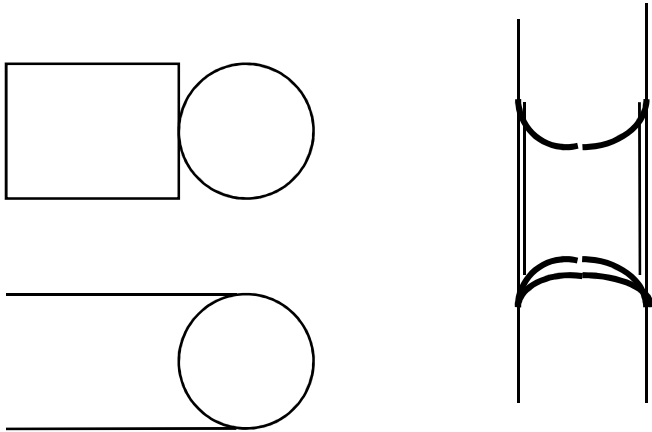

**TUBE CUTTING
TEMPLATE**

Construction Tips & Techniques

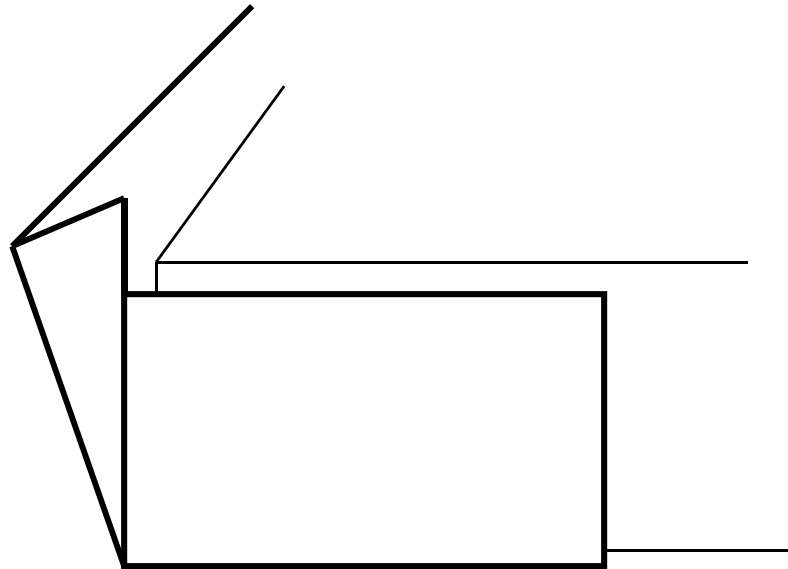

**FOLD & OVERLAP
CARDBOARD
AROUND CORNERS**

Construction Tips & Techniques

**Crease/Score a line
for a nice**

**STRAIGHT
FOLD**

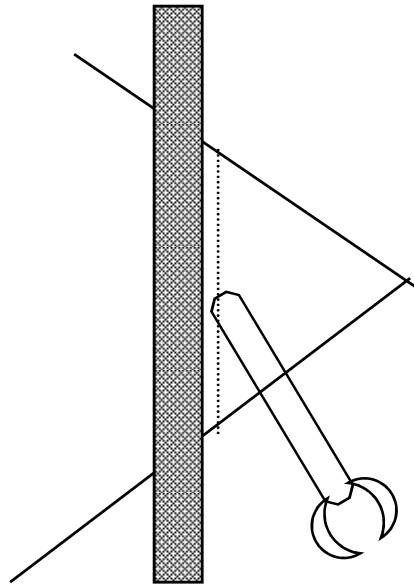

Construction Tips & Techniques

Multiple cardboard layers
“glued” together on the sides
strengthen the hull

Multiple trapezoid-shaped pieces
“glued” together to form a
“support block”

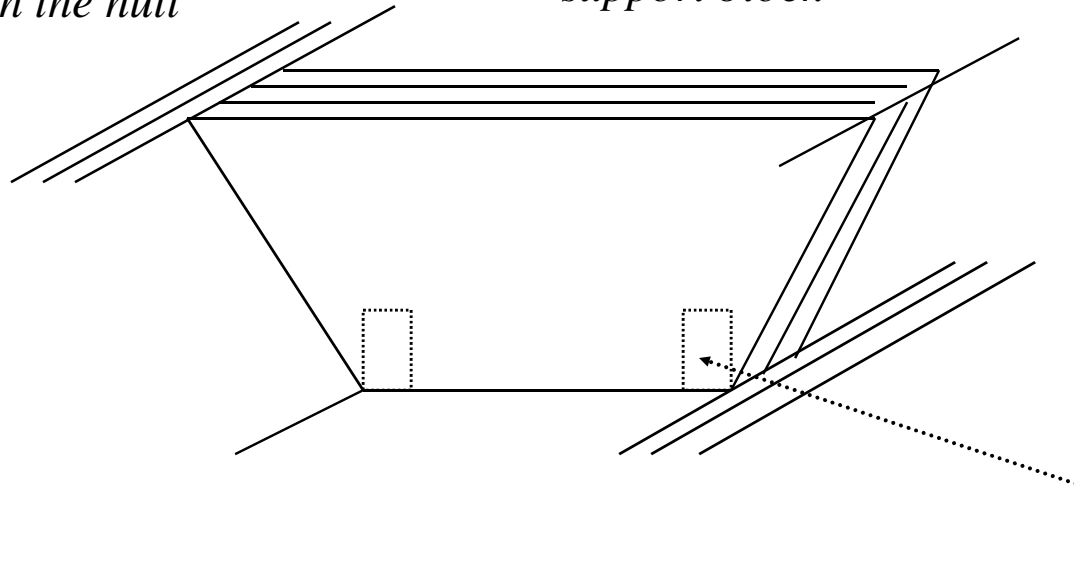

A sheet of cardboard
could be folded &
“glued” together to
form *tubes/beams*

